

# RoofSupport PVbox



Conduct  
Stockholm 31  
2993LM Barendrecht

## SB.4.NF.T1.NSX.10IN.10OUT.MT

Details:



RoofSupport PVbox

CP.4.NF.T1.NSX.10IN.10OUT.MT

Cover

Drawn by: S. Vanpraet

Date: 28-2-2018

Page

001

# INDEX

PAGE	DESCRIPTION	DRAWING TYPE	DRAWN BY	DATE
001	Cover	Title page / cover sheet	S. Vanpraet	28-2-2018
050	Index	Table of contents	S. Vanpraet	28-2-2018
100	Power supply	Schematic multi-line	S. Vanpraet	28-2-2018
101	Power supply	Schematic multi-line	S. Vanpraet	28-2-2018
600	Cabinet layout	Model view	S. Vanpraet	28-2-2018
601	Cabinet layout	Model view	S. Vanpraet	28-2-2018
700	Product list	Summarized parts list	S. Vanpraet	28-2-2018



RoofSupport PVbox  
 CP.4.NF.T1.NSX.10IN.10OUT.MT

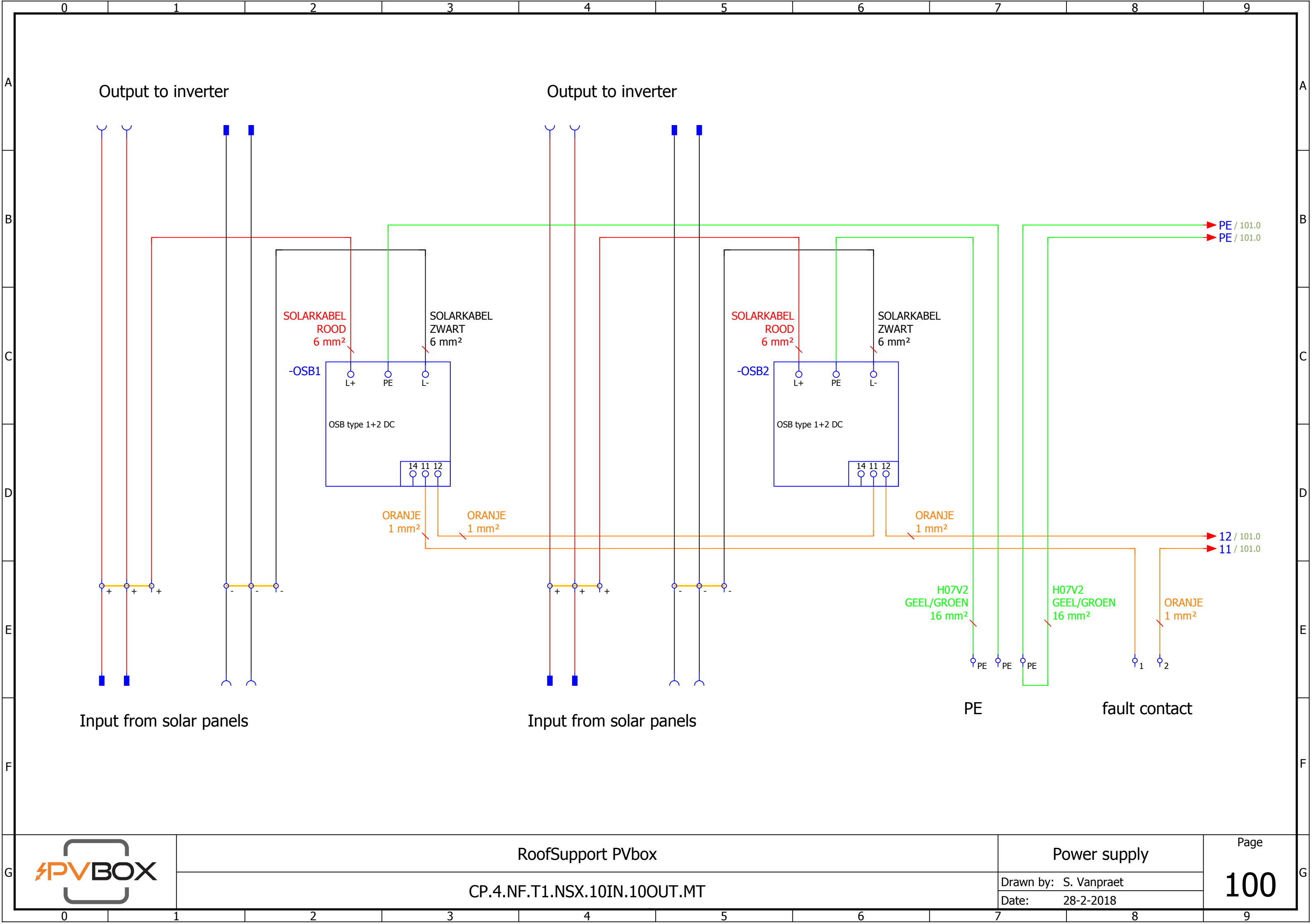

RoofSupport PVbox  
 CP.4.NF.T1.NSX.10IN.10OUT.MT

Output to inverter

Output to inverter

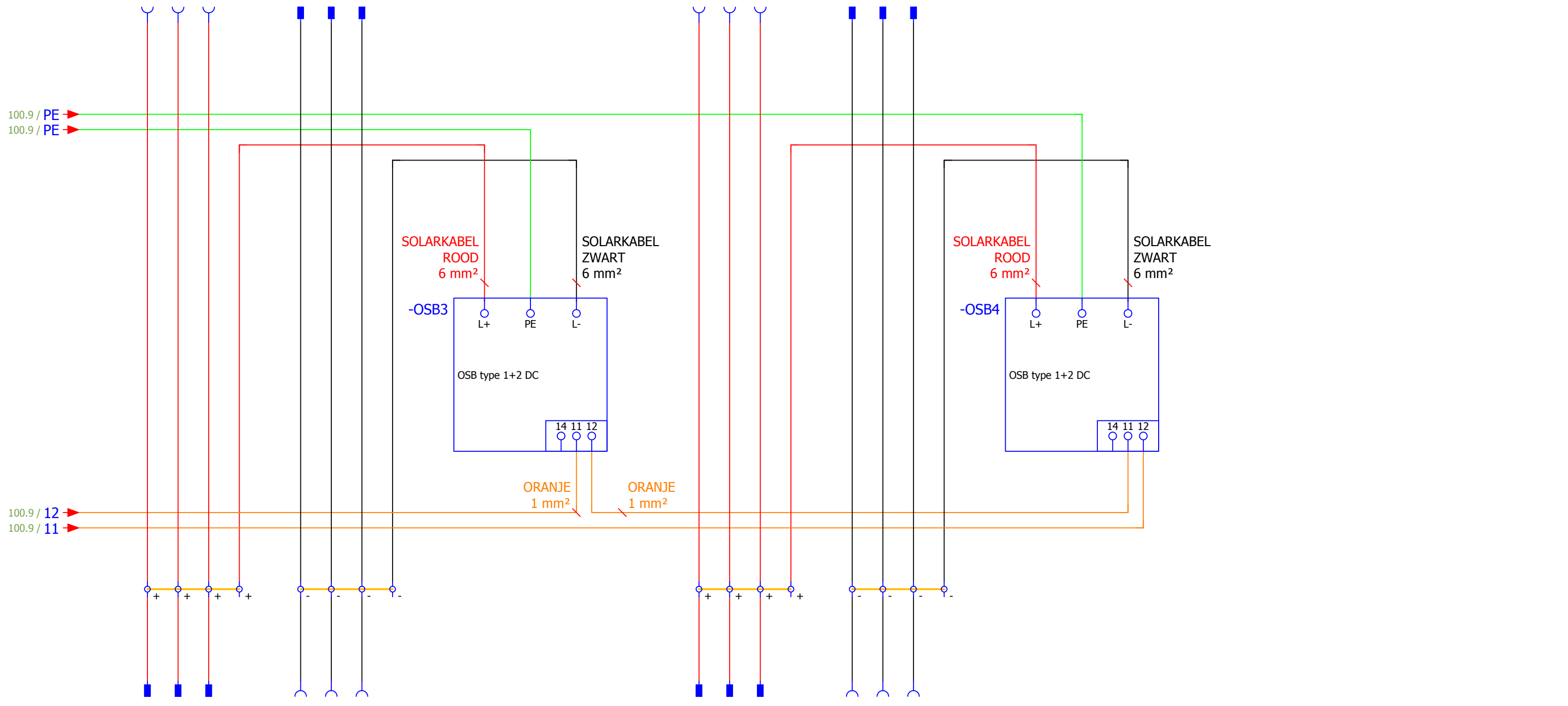

Input from solar panels

Input from solar panels



RoofSupport PVbox  
 CP.4.NF.T1.NSX.10IN.10OUT.MT

Power supply

Drawn by: S. Vanpraet  
 Date: 28-2-2018

Page

101

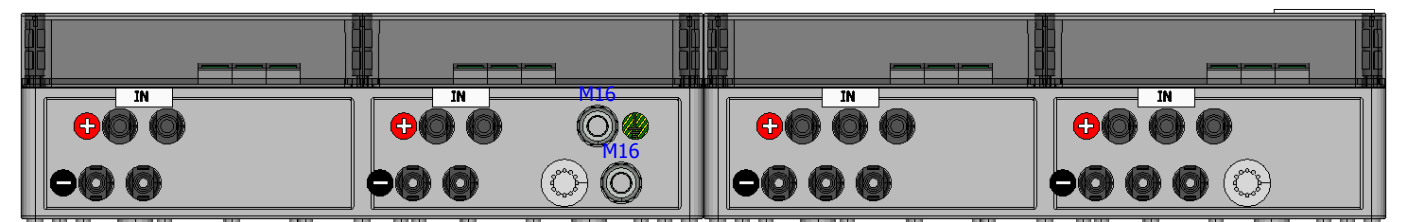
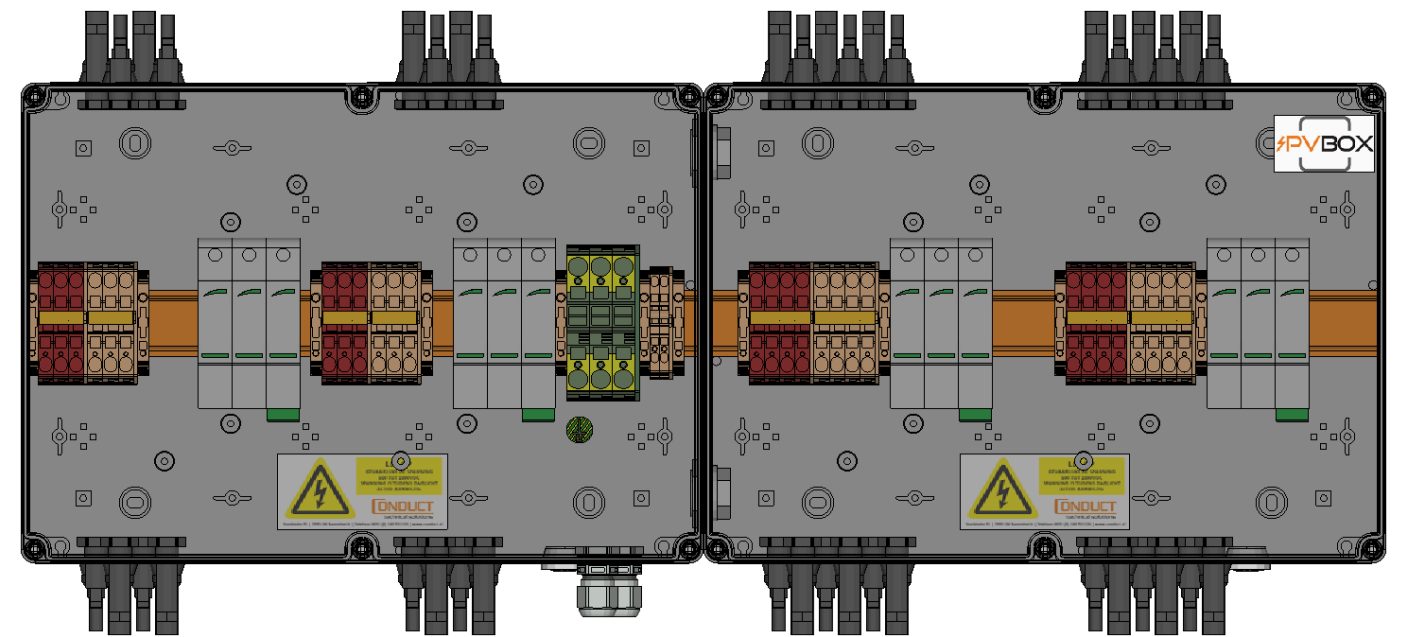
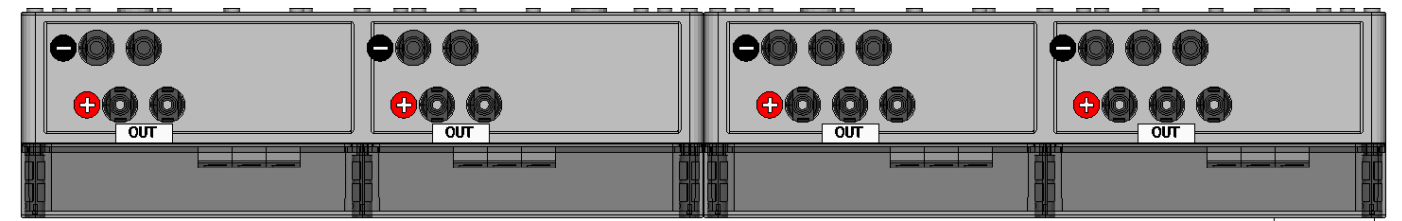
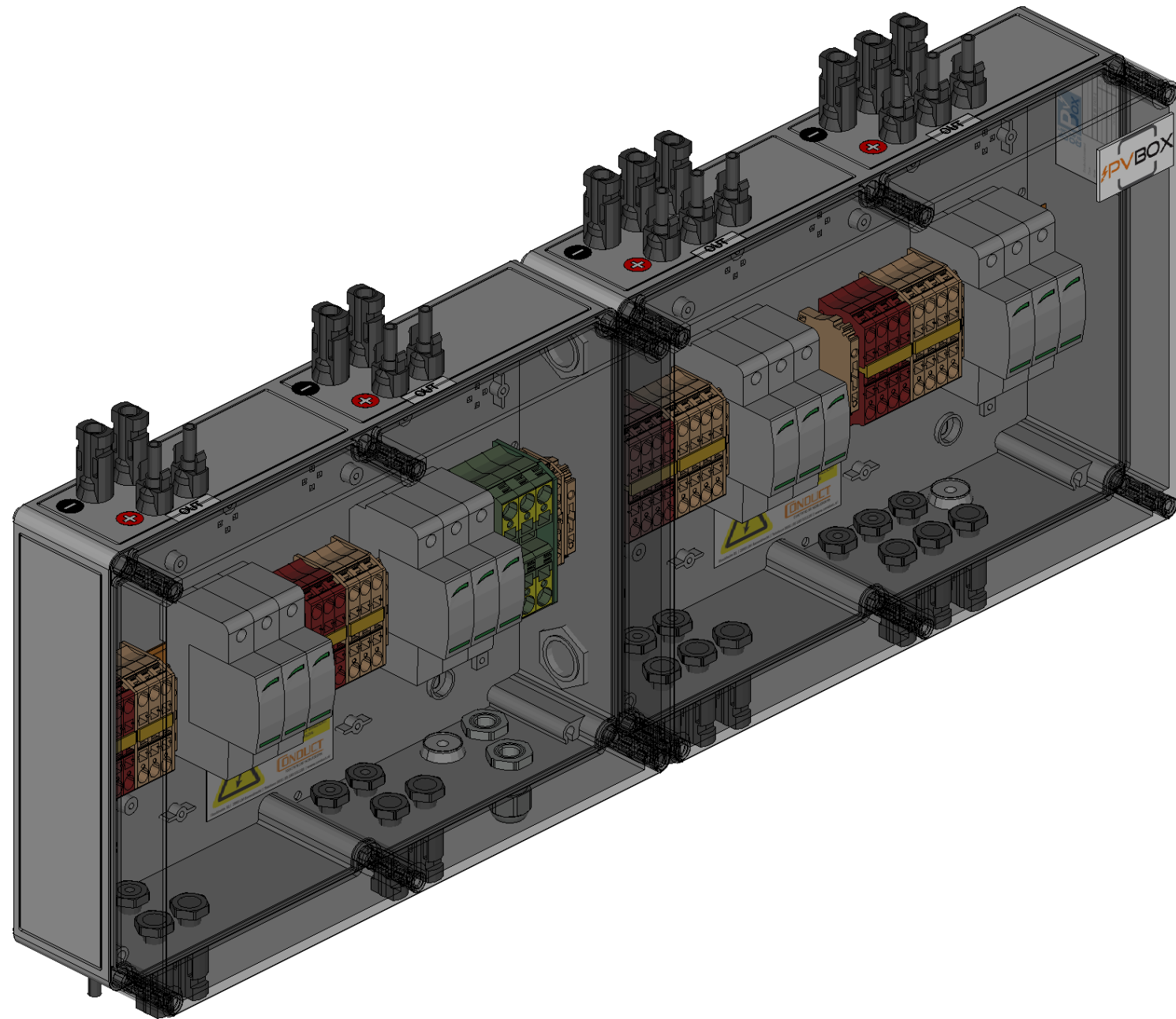

RoofSupport PVbox  
 CP.4.NF.T1.NSX.10IN.10OUT.MT

Cabinet layout

Drawn by: S. Vanpraet  
 Date: 28-2-2018

Page

600

0	1	2	3	4	5	6	7	8	9
DEVICE CODE	DESCRIPTION			TYPE	PART NUMBER		MANUFACTURER		
OSB1	OSB Type 1-2 DC			PSC3-5/1000 PV IR	77738378		Cirprotec		
OSB2	OSB Type 1-2 DC			PSC3-5/1000 PV IR	77738378		Cirprotec		
OSB3	OSB Type 1-2 DC			PSC3-5/1000 PV IR	77738378		Cirprotec		
OSB4	OSB Type 1-2 DC			PSC3-5/1000 PV IR	77738378		Cirprotec		

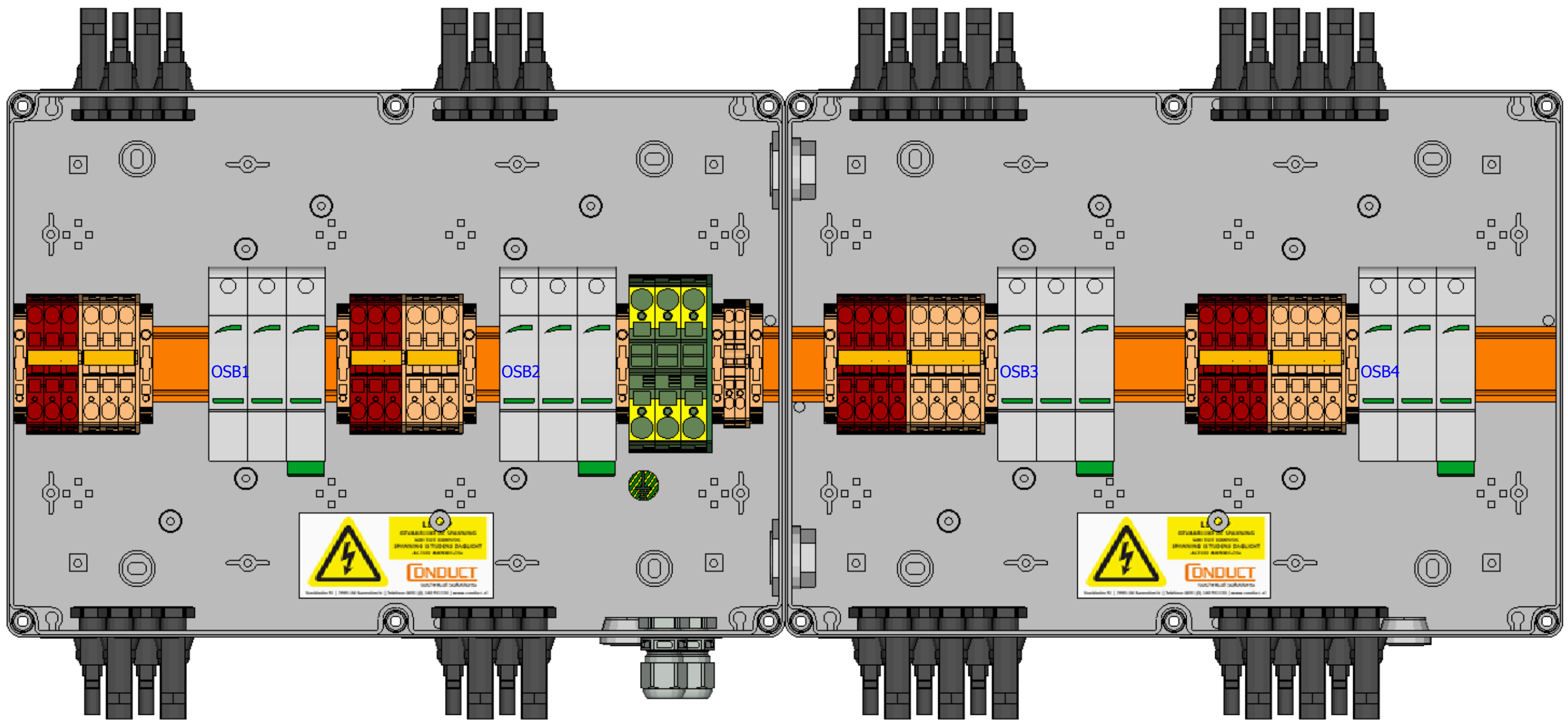

RoofSupport PVbox  
 CP.4.NF.T1.NSX.10IN.10OUT.MT

Cabinet layout

Drawn by: S. Vanpraet  
 Date: 28-2-2018

Page

601

# PRODUCT LIST

QUANTITY	DEVICE CODE	DESCRIPTION	TYPE	PART NUMBER	MANUFACTURER
0,71 m		Din rail EN 50 022 ( 35x7,5 )	TS 35_7,5		
4	OSB1...OSB4	OSB Type 1-2 DC	PSC3-5/1000 PV IR	77738378	Cirprotec
4		Jumper bar 3 connections	ZQI 6/3 YE	3764.8	Conta-Clip
4		Jumper bar 4 connections	ZQI 6/4 YE	3765.8	Conta-Clip
11		End bracket	ZES 35/2	3811.2	Conta-Clip
14		Terminal with tension clamp	ZRK6/2A rood	3581.9	Conta-Clip
8		End plate	ZAP6/2A beige	3760.2	Conta-Clip
14		Terminal with tension clamp	ZRK6/2A Beige	3581.2	Conta-Clip
3		PE Terminal with tension clamp	ZSL16/2A	3637.2	Conta-Clip
1		End plate	ZAP16/2A groen	3799.1	Conta-Clip
2		Terminal with tension clamp	ZRK2,5/2A beige	3500.2	Conta-Clip
1		End plate	ZAP2,5/2A beige	3700.2	Conta-Clip
2		Sticker "Let op: gevaarlijke DC spanning"	Sticker	Sticker	GTV
1		Sticker Type	Sticker	Sticker	GTV
1		Sticker PVbox	Sticker	Sticker	GTV
20		Female connector solar MC4	PV-ADSP4-S2/6	32.0079P0001	Multicontact
20		Male connector solar MC4	PV-ADBP4-S2/6	32.0078P0001	Multicontact
2		Connection for cabinet	KS M25	19202501	Spelsberg
2		Cabinet 361x254x111 mm	TK PS 3625-11-to	11101201	Spelsberg
2		Ventilation seal M20	BST M20	26242001	Spelsberg
2		External fixing lugs	TK ABL	19400101	Spelsberg
2		Cable gland M16X1,5	ESKV16	10066411	Wiska
2		Gland locknut M16X1,5	EMUG16	10060771	Wiska



RoofSupport PVbox

CP.4.NF.T1.NSX.10IN.10OUT.MT

Product list

Drawn by: S. Vanpraet

Date: 28-2-2018

Page

700